



Safety Warning

Before installation, please read the "Safety Warning" to ensure proper installation of the product.

■ In the event of improper installation, the possible situations that may occur to user are stated below.

 **Warning** This tag indicates contents that may lead to risks of serious injuries and/or death

 **Caution** This tag indicates contents that may lead to injuries and /or product damage

■ Please proceed with caution for contents with the following tag

 This tag indicates contents that should be avoided

 Please carry out all actions that has this tag

 **Warning** About product usage

 Please do not use roduct for unintended purpose or application. Product failure may result in injuries.

 Load heavier than the statd load capacity may result in product failure and possible risks of injuries.

 Please do not subject product to load capacity and impact force larggerthan what is stated.
Product failure may occur, leading to risks to risks of injuries.

 **Caution** About product maintenance

Wipe away cosmetics and/or chemical product stains when found.
 Long term staines will result in corrosion, discolouration, and/or deterioration which may lead to product breakage and result in injuries.

 Wipe with soft dry cloth for maintenance. When necessary, use a damp cloth with diluted detergent and dried off with a dry cloth.
Do not use gasoline (Benzin), thinner, alcohol, acidic/alkali-based detergent and/or cleansers to clean product.

AC-824(Door Viewer)

※Please read installation manual before installation and pass it to user for safe keeping
※Pass attached installation tool (if any) to user along with the installation manual.

Package Contents

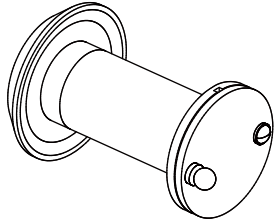

DoorViewer x1



Installation Instruction x1



Safety Warning x1

Installation Procedure

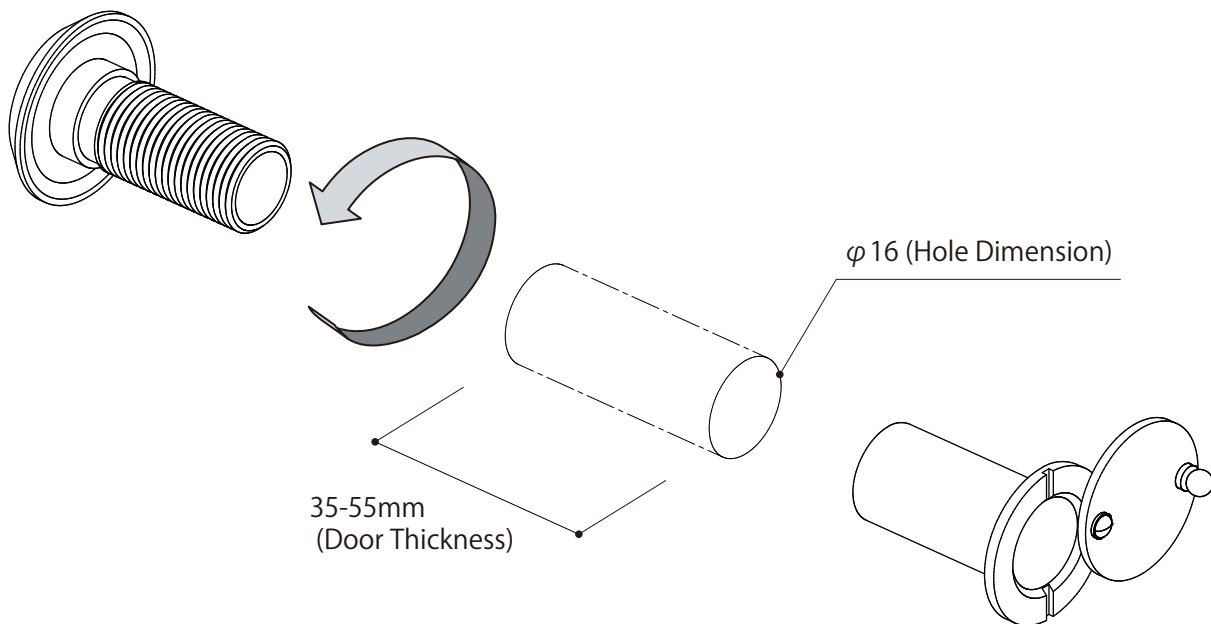

Product Specification

Type: Door Viewer
Product ID: AC-824
Material: Brass
Product Dimension: 30x50x30mm
Angle of Sight: 200°

