

AC-888 (Door Stopper)

※Please read this section before installation. This manual must be handed over to the user after installation and should not be discarded.

Safety Precautions (Must be observed)

- This product is for hinged doors with heavy doors (80kg or less) or outset sliding doors with medium weight (40kg or less).
 - This product is not waterproof. Do not install this product outdoors, in the bathroom, or any other place where it will be exposed to water or excessive moisture. The product may fail and cause injury or damage due to the corrosion of parts.
 - After installation, please check the product once more to ensure that it has been installed firmly. Failure to do so will cause the product to wobble resulting in a risk of damaging the door or wall surfaces or cause injuries.
 - Please do not use product for any unintended purposes or applications. Doing so may cause product failure and result in injuries.
 - To clean, wipe gently with a soft, dry cloth. For stubborn stains, wipe with a soft cloth dipped in a mild neutral detergent (5-10%) diluted in water and wipe off with a fresh soft, dry cloth.
- Do not use gasoline (Benzine), paint thinner, alcohol, toilet detergents, fungicides, chlorine detergents, acid or alkaline detergents or cleansers.

Package Contents

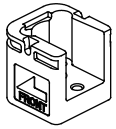

Body × 1

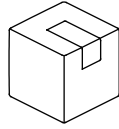

Bumper × 1

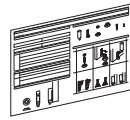

Instruction Manual
(This paper) × 1

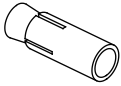

Anchor Plug × 1

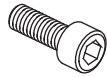

Body Fixing Screw
(M10 Hex) × 1



Spring Washer (Large) × 1



Anti-rotation Screw × 1



Installation Screw × 3



Spring Washer (Small) × 3

Product Specification

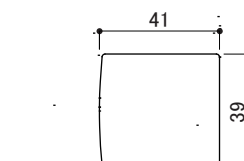
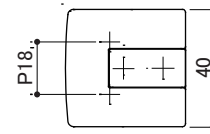

Wood
Flooring

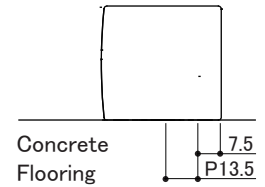

Concrete
Flooring

Installation Procedure

◎For Wood Flooring

- ① Determine the mounting position and pay attention to the orientation of the main body. Install product with the installation screws and spring washers provided.
- ② Pay attention to the direction of the bumper and push it in until the main body is completely covered.

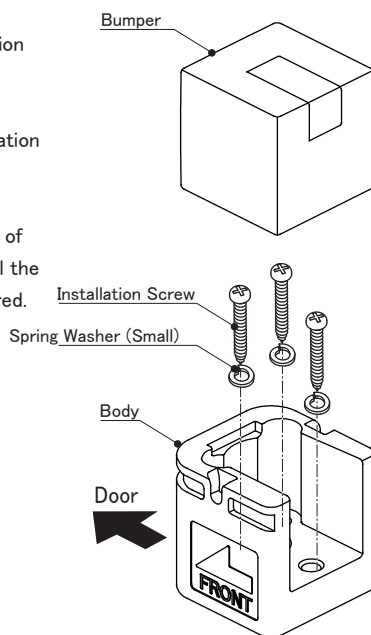

※To remove the bumper, pull it alternately on the left and right.

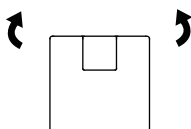

◎For Concrete Flooring

- ① Determine the mounting position and drill holes for the anchor plugs and anti-rotation screws.
- ② Drive the attached cut anchor into the floor with a mallet and fix the main body with the body fixing screw, spring washer, and anti-rotation screw.
- ③ Pay attention to the direction of the bumper and the main body and push it in until the main body is completely covered.

※Ensure that the anchor is firmly seated.

