

## Sanitary Accessory Installation Instruction Sheet

### SC-811 ■ SC-811L (Towel Rail)

#### Safety Warning

- \* Please be sure to read "Safety Warning" before installation to ensure product will be installed properly.
- \* Customers who have purchased this product from the online shop should read the attached "Disclaimers and Warranties" and "Precautions" before installation.
- \* Do not dispose the installation sheet after installation, instead please pass it to the product user.
- \* Pass all tools that have been provided to product user.



■ The following displays shows the levels of harm or damage if product is not installed properly.

 <b>Warning</b> This display warns the possibility of death or serious injury.	 <b>Caution</b> This display warns the possibility of injury or possibility of physical damage.
-----------------------------------------------------------------------------------------------------------------------------------------------------------------	-----------------------------------------------------------------------------------------------------------------------------------------------------------------------------------



■ The following symbols shows the precautions that needs to be observed.

 This symbol is used to identify prohibited actions that must not be carried out.	 This symbol is used to identify mandatory actions that must be carried out.
--------------------------------------------------------------------------------------------------------------------------------------------------------------------	---------------------------------------------------------------------------------------------------------------------------------------------------------------



#### About installation

- Please do not install product onto non-reinforced walls. Product may fall off and result in injury.
  - \* Installers can fix a 9mm or thicker plywood, or something, solid behind the product.
  - \* Product may not be installed stably on lightweight metal. As a precaution, please reinforce it with a wooden plank.
  - \* Do not install product on ALC (Autoclaved lightweight concrete), lightweight metal, or spaces between concrete blocks.
-  Please ensure that the installation of Pedestal is done according to the illustration. If installed differently, product may wobble and drop off, resulting in injuries.
-  After installation, please check to ensure product has been installed properly. If product has not been installed properly, it may wobble and drop off, resulting in injuries.

#### About product usage

-  Do not use product for unintended purpose or application. Product failure may result in injury.
-  Do not load heavier than the stated load capacity. Product failure may result in injury.
-  Do not apply excessive force onto product. Product failure may occur and lead to injury.

#### About product maintenance

-  Wipe away any stain of cosmetic or chemical product when found. Leaving stains on product may lead to discolouration, corrosion and/or deterioration and result in breakage and injury.
-  Wipe with a soft, damp cloth. When necessary, wipe a damp cloth with mild detergent and finish with a soft, dry cloth. Do not use gasoline (Benzene), thinner, alcohol, or acidic/alkaline based detergent and/or cleanser to clean the product.

#### Product Specification

Type	Towel Rail
Product Code	SC-811 ■ SC-811L
Material	Brass
Product Dimension	536 x 48 x 39.5mm ■ 686 x 48 x 39.5mm
Load Capacity	98N (10kgf)

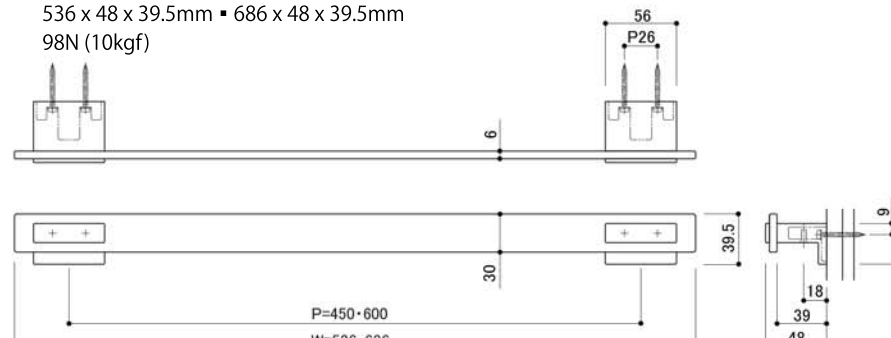

#### Package Contents

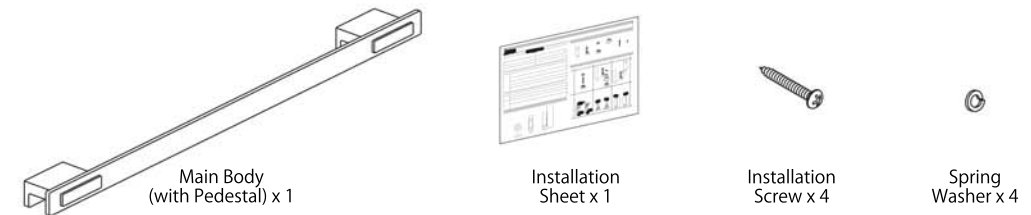

#### Installation Procedure

##### ◎ Installation Procedure

1. Loosen Fixing Screws and remove Pedestals from Main Body.
2. Install Pedestals to wall using the provided Spring Washers and Installation Screws.
3. Install Main Body to Pedestals and secure by screwing Fixing Screws back.
4. Check product after installation to ensure it has been installed properly.

